

D5 Junction details

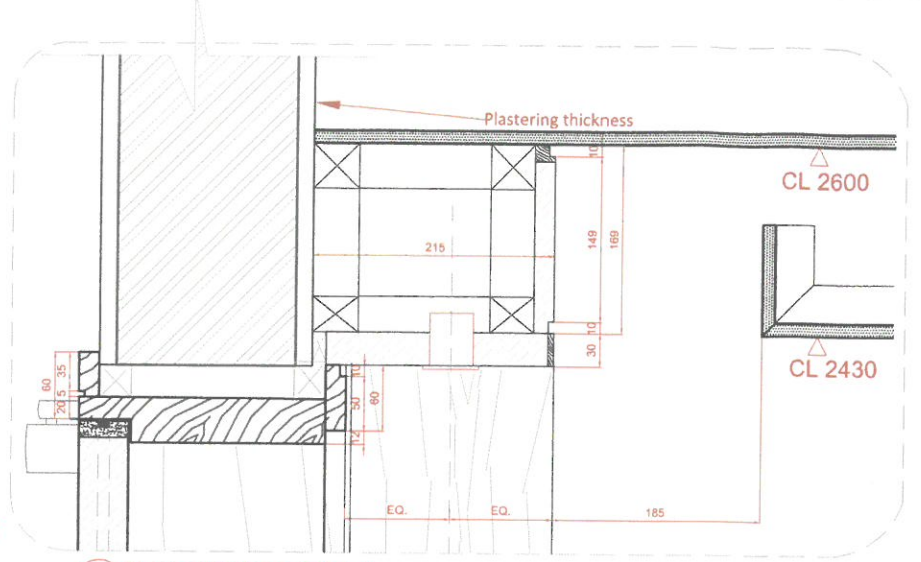

D1 Typical Bulkhead detail

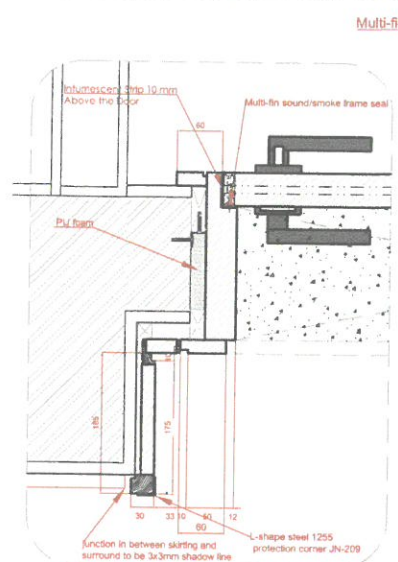

D3 Typical Frame detail

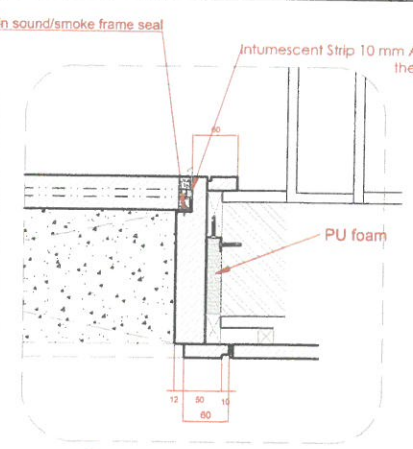

D1 Typical Frame detail

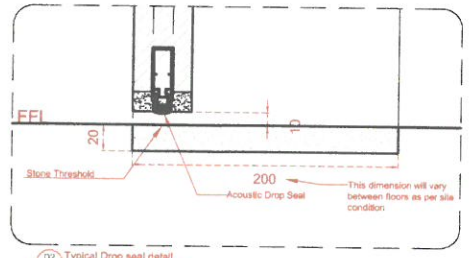

D2 Typical Drop seal detail

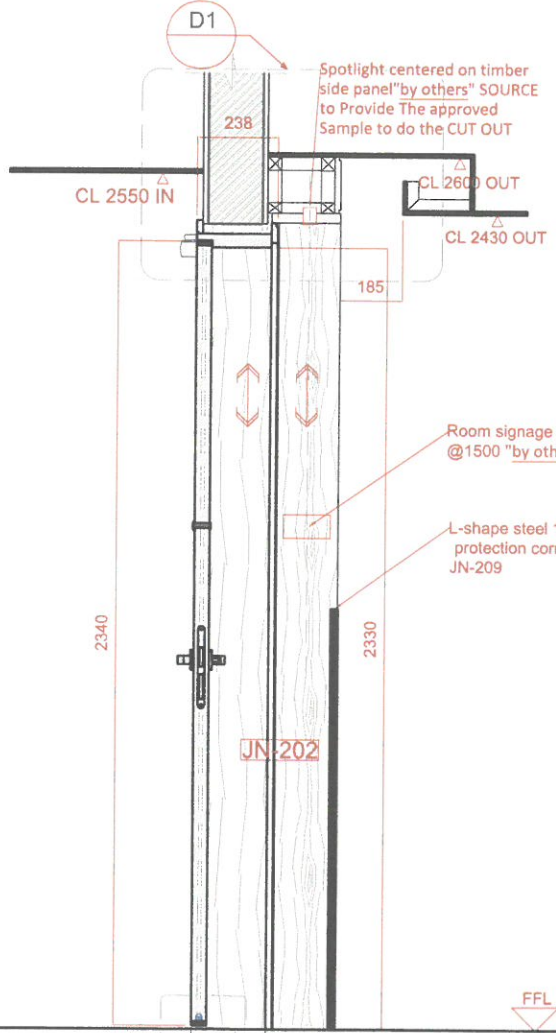

D2 Section

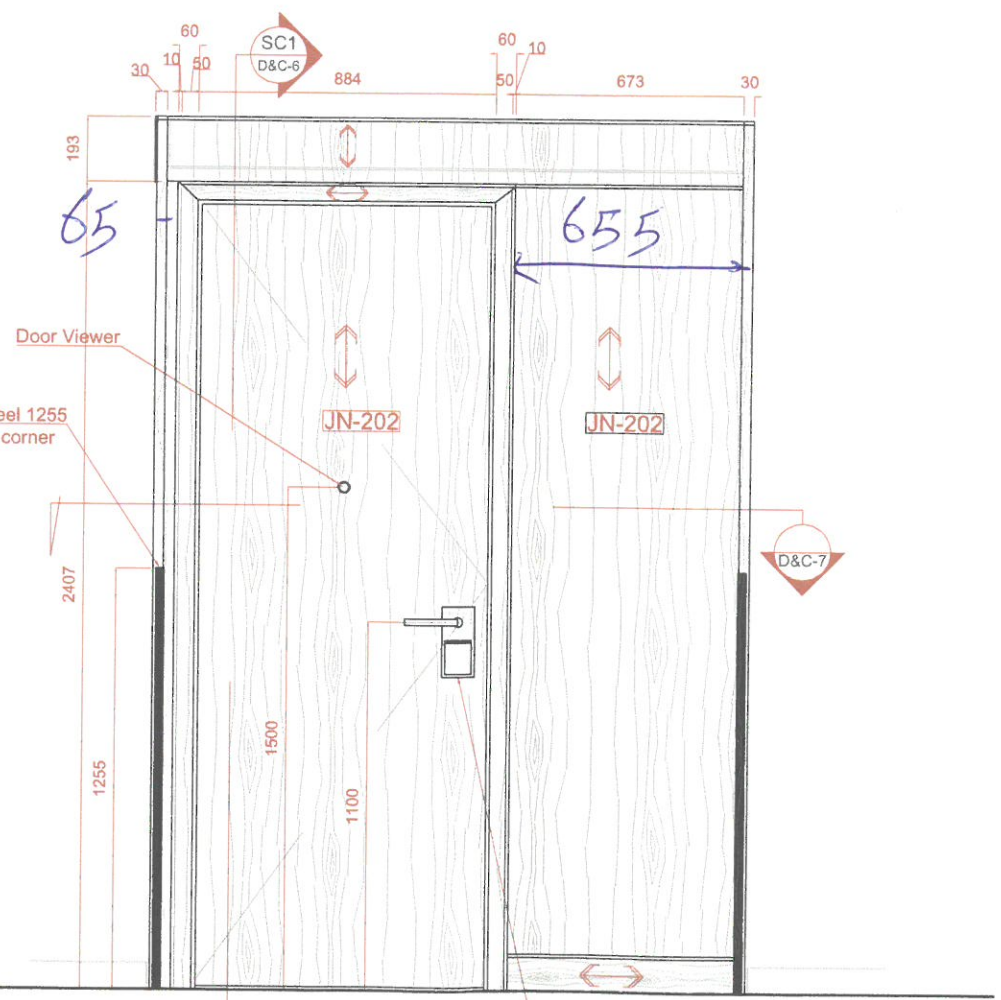

A outside view

B D&C-5

**CORRIDOR/DOOR WALL PANELING TYPE B**

**1-B-2**

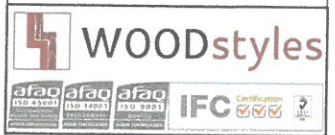

www.wood-styles.com

Copyright of designs shown herein is retained by this office. Authority is required for any reproduction. © Copyright Wood-styles Ltd.

Nigeria, Lagos +234 80 9037 9888  
Email: info@wood-styles.com

Project  
Hyatt Regency Hotel  
NG-Lagos-Ikeja

Owner

Date	Description
01-09-2023	A FOR APPROVAL
25-10-2023	B FOR APPROVAL
18-12-2023	C FOR APPROVAL

**For Approval**

Project No. : NG23 - Hyatt Regency Hotel  
Scale : A3 = 1 : 25  
Drawn by : Damil  
Checked : Kinan  
Cad File : CAD File

Sheet title  
Corridor Cladding Type B  
Shop Drawing

**Typical Floor 1-5**

Dwg No. **D&C-6** No. **C**